

Модель	Высота, мм	Межцентровое расстояние N мм	Глубина мм	Вес, кг/сек	Теплоотдача, Watt	Price RAL9016 €		Price Cat. 1 €		Price Cat. 2 €		Price ZN+RAL9016 €		Price ZN+Cat. 1 €		Price ZN+Cat. 2 €		
						Δt 50	за радиатор	за метр	за радиатор	за метр	за радиатор	за метр	за радиатор	за метр	за радиатор	за метр	за радиатор	за метр
RV211	70	34	73	5,70	369	228	102	273	122	296	133	273	218	328	261	355	283	
RV221	70	34	104	6,80	460	259	137	310	164	336	178	310	277	372	333	403	361	
RV321	70	34	134	9,45	628	298	166	358	199	388	216	358	358	429	430	465	465	
RV431	70	34	195	13,30	837	353	245	424	294	459	318	424	516	509	619	551	671	
RV541	70	34	256	17,05	1077	407	299	489	359	530	389	489	643	587	771	636	836	
RV212	140	104	73	11,50	528	246	171	296	205	320	222	296	397	355	477	384	517	
RV222	140	104	104	13,70	651	275	280	330	337	357	365	330	567	396	680	429	737	
RV322	140	104	134	19,10	915	323	335	387	401	420	435	387	720	465	865	504	937	
RV432	140	104	195	26,85	1256	391	483	470	579	509	627	470	1 027	564	1 232	611	1 335	
RV542	140	104	256	34,50	1660	439	687	526	824	570	892	526	1 400	632	1 680	684	1 820	
RV213	210	174	73	17,25	689	282	215	339	258	367	279	339	545	407	654	441	709	
RV223	210	174	104	20,65	850	320	315	384	378	416	410	384	724	460	868	499	941	
RV323	210	174	134	28,70	1172	396	373	475	448	515	485	475	927	570	1 112	618	1 205	
RV433	210	174	195	40,35	1625	517	570	620	685	672	742	620	1 359	745	1 631	807	1 767	
RV543	210	174	256	51,90	2148	655	793	786	952	852	1 031	786	1 819	944	2 182	1 022	2 364	
RV214	280	244	73	23,00	865	383	287	459	344	497	373	459	729	551	874	597	947	
RV224	280	244	104	27,45	1076	370	393	444	471	481	510	444	931	533	1 117	578	1 210	
RV324	280	244	134	38,30	1425	406	509	487	611	527	662	487	1 251	584	1 501	633	1 626	
RV434	280	244	195	53,90	1979	534	751	641	902	694	977	641	1 802	769	2 162	833	2 342	
RV544	280	244	256	69,35	2587	660	1 033	792	1 239	858	1 342	792	2 398	950	2 878	1 029	3 118	
RV211/1	70	34	134	7,90	477	346	199	416	238	450	258	416	370	499	444	540	481	
RV321/1	70	34	195	11,60	737	436	252	523	303	567	328	523	496	628	596	680	645	
RV431/1	70	34	256	15,50	958	473	331	567	397	614	430	567	656	681	787	737	853	
RV541/1	70	34	317	19,20	1177	526	386	631	463	684	502	631	784	757	940	820	1 019	
RV212/1	140	104	134	15,90	717	375	379	450	454	487	492	450	720	540	864	585	936	
RV322/1	140	104	195	23,50	1088	442	461	530	553	574	599	530	946	636	1 135	689	1 229	
RV432/1	140	104	256	31,20	1373	486	588	583	706	631	765	583	1 227	699	1 472	758	1 595	
RV542/1	140	104	317	38,90	1676	541	812	649	975	703	1 056	649	1 625	779	1 950	844	2 112	
RV213/1	210	174	134	23,90	953	438	422	525	506	569	549	525	906	630	1 087	683	1 177	
RV323/1	210	174	195	35,30	1391	545	510	654	612	708	663	653	1 202	784	1 442	850	1 563	
RV433/1	210	174	256	47,00	1832	629	686	755	823	818	891	755	1 608	906	1 929	982	2 090	
RV543/1	210	174	317	58,50	2251	773	917	927	1 100	1 005	1 192	927	2 077	1 113	2 493	1 206	2 700	
RV214/1	280	244	134	31,90	1205	502	519	602	622	653	674	602	1 155	723	1 386	783	1 502	
RV324/1	280	244	195	47,20	1677	566	674	679	809	735	877	679	1 598	814	1 917	882	2 077	
RV434/1	280	244	256	62,80	2375	666	899	800	1 079	866	1 169	800	2 128	960	2 554	1 040	2 766	
RV544/1	280	244	317	78,20	2952	781	1 158	937	1 390	1 016	1 505	937	2 696	1 125	3 235	1 219	3 505	

Пример расчета RV211 - 1,8 RAL 9016 = 228 + 102*1,8 = 412 €

Повышенное давление 10 атм. +12%

Длина приборов от 500 до 6000 мм

Декоративная приварная решетка (цена за метр в €)

для 211-214	28,10
для 221-224	68,46
для 321-324	54,59
для 431-434	82,03
для 541-544	109,15
для 211/1-214/1	54,59
для 321/1-324/1	82,03
для 431/1-434/1	105,95
для 541/1-544/1	136,78

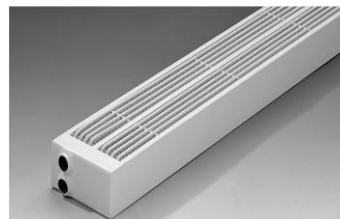

Приварные декоративные ноги (цена за штуку в €)

180,94

При высоте RV от 70 до 140 мм свыше 1600 мм - 3 ноги
 свыше 3700 мм - 4 ноги

При высоте RV от 210 до 280 мм свыше 2700 мм - 3 ноги



Модель RV 322/1

только на готовый пол, не возможно для моделей 211-214 + 221-224
 Для моделей 211/1-214/1 возможно только подключение 243-423

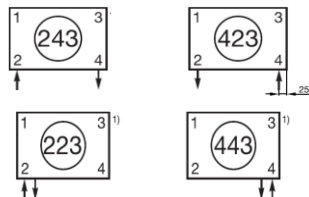

51,95

1) подводка располагается перпендикулярно лицевой плоскости радиатора





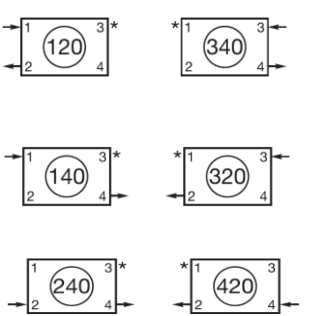
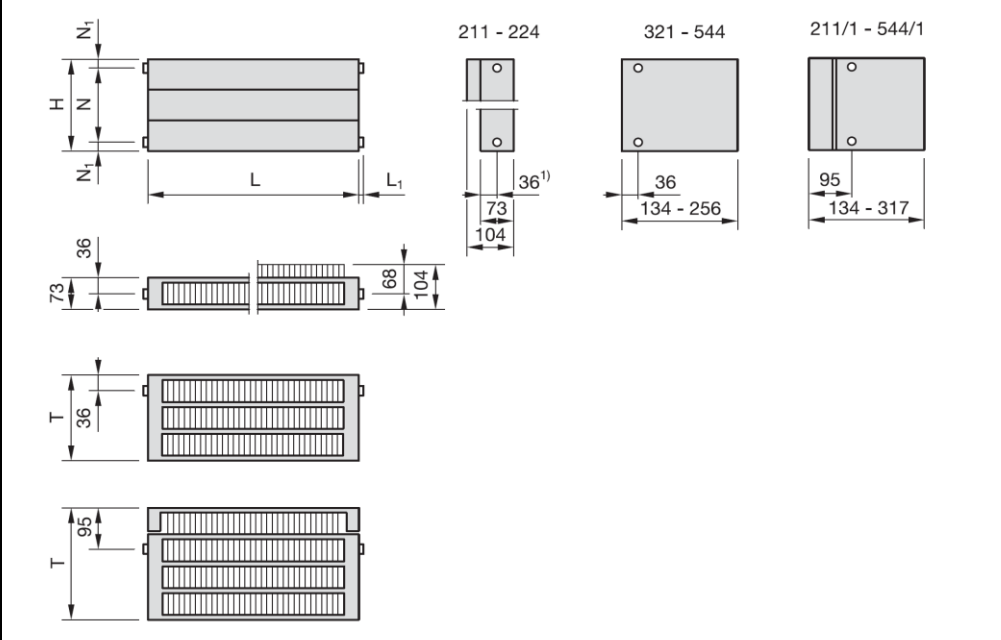
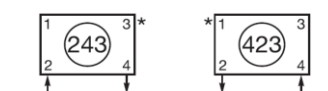
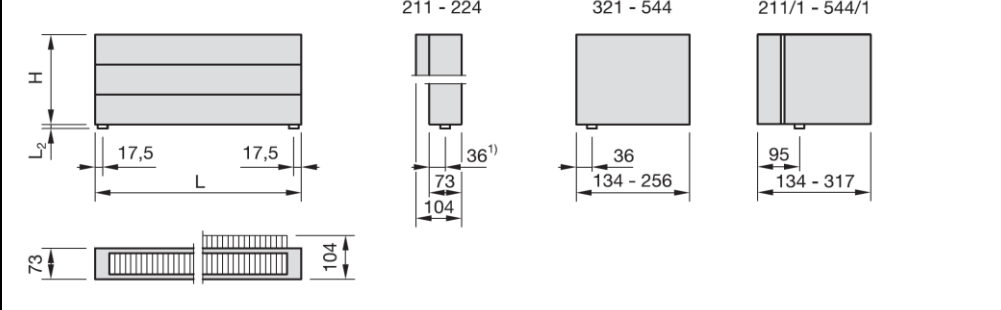
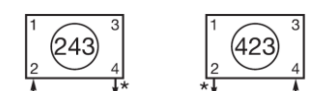
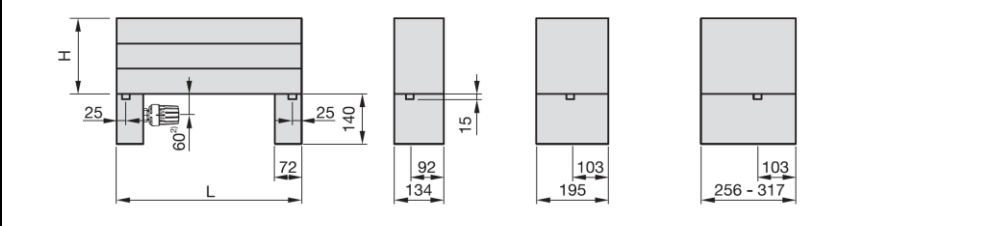

Виды подключений

Price €

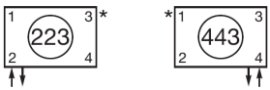
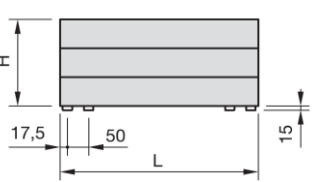
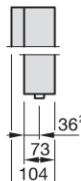
 <p>1) для моделей 221-224 + 32 мм</p>	<p>0,00</p> <p>0,00</p> <p>0,00</p>																	
 <p>1) для моделей 221-224 + 32 мм</p>	<p>51,95</p>																	
	<p>51,95</p>	 <table border="1" data-bbox="829 1590 1356 1680"> <thead> <tr> <th>dimension connection</th> <th>Ø 3/16"</th> <th>1/8"</th> <th>3/16"</th> </tr> </thead> <tbody> <tr> <td>N₁</td> <td>18</td> <td>18</td> <td>26</td> </tr> <tr> <td>L₁</td> <td>2</td> <td>2</td> <td>2</td> </tr> <tr> <td>L₂</td> <td>15</td> <td>17</td> <td>21</td> </tr> </tbody> </table>	dimension connection	Ø 3/16"	1/8"	3/16"	N ₁	18	18	26	L ₁	2	2	2	L ₂	15	17	21
dimension connection	Ø 3/16"	1/8"	3/16"															
N ₁	18	18	26															
L ₁	2	2	2															
L ₂	15	17	21															

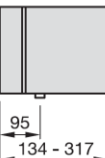
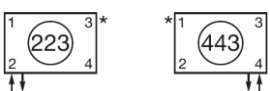
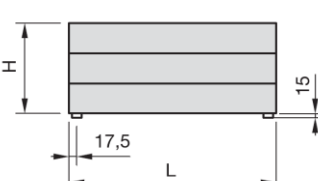
Виды подключений

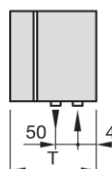
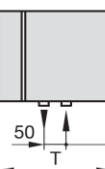
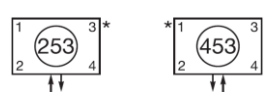
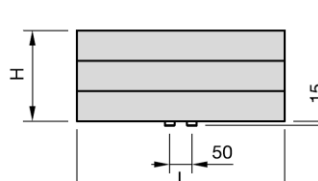
Price €

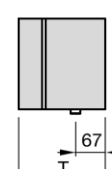
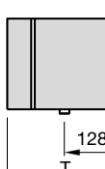
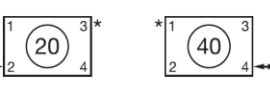
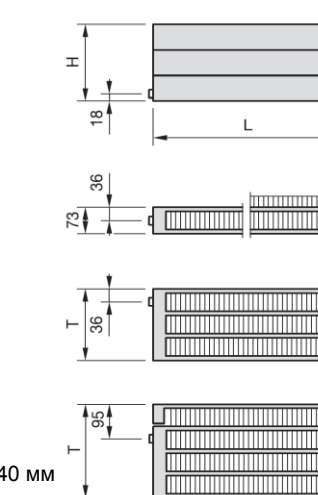
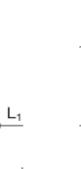
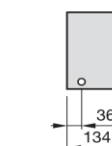
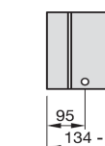
 <p>2)²⁾ для моделей 221-224 + 30 мм</p>	<p>176,53</p>	 <div style="display: flex; justify-content: space-around;"> <div data-bbox="933 302 1029 526"> <p>211 - 224</p>  </div> <div data-bbox="1093 302 1220 504"> <p>321 - 544</p>  </div> <div data-bbox="1276 302 1396 504"> <p>211/1 - 544/1</p>  </div> </div>												
 <p>1)¹⁾ подводка располагается перпендикулярно лицевой плоскости радиатора</p>	<p>51,95</p>	 <div style="display: flex; justify-content: space-around;"> <div data-bbox="933 582 1029 851"> <p>211 - 224 211/1 - 214/1</p>  </div> <div data-bbox="1093 582 1220 851"> <p>321 - 324 321/1 - 324/1</p>  </div> <div data-bbox="1276 582 1396 851"> <p>431 - 544 431/1 - 544/1</p>  </div> </div>												
	<p>162,08</p>	 <div style="display: flex; justify-content: space-around;"> <div data-bbox="933 896 1029 1164"> <p>211 - 224 211/1 - 214/1</p>  </div> <div data-bbox="1093 896 1220 1164"> <p>321 - 434 321/1 - 434/1</p>  </div> <div data-bbox="1276 896 1396 1164"> <p>541 - 544 541/1 - 544/1</p>  </div> </div>												
 <p>1)¹⁾ подключение возможно начиная с высоты 140 мм</p> <p>2)²⁾ для моделей 221-224 + 30 мм</p>	<p>51,95</p>	 <div style="display: flex; justify-content: space-around;"> <div data-bbox="933 1198 1029 1411"> <p>211 - 224</p>  </div> <div data-bbox="1093 1198 1220 1388"> <p>321 - 544</p>  </div> <div data-bbox="1276 1198 1396 1388"> <p>211/1 - 544/1</p>  </div> </div> <table border="1" style="margin-top: 10px;"> <thead> <tr> <th colspan="2">Maximum lengths for 1-tube connection 20/40 and 23/43</th> </tr> <tr> <th>Height mm</th> <th>Length per radiator mm</th> </tr> </thead> <tbody> <tr> <td>70</td> <td>2500</td> </tr> <tr> <td>140</td> <td>3600</td> </tr> <tr> <td>210</td> <td>3200</td> </tr> <tr> <td>280</td> <td>3000</td> </tr> </tbody> </table>	Maximum lengths for 1-tube connection 20/40 and 23/43		Height mm	Length per radiator mm	70	2500	140	3600	210	3200	280	3000
Maximum lengths for 1-tube connection 20/40 and 23/43														
Height mm	Length per radiator mm													
70	2500													
140	3600													
210	3200													
280	3000													

Виды подключений

Price €

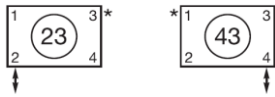
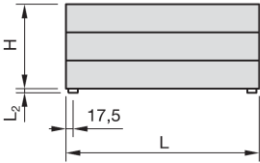
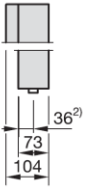
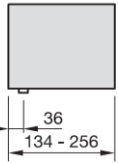
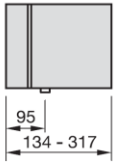
	<p>25,97</p>		<p>211 - 224</p> 	<p>321 - 544</p> 	<p>211/1 - 544/1</p> 																
<table border="1" style="width: 100%; border-collapse: collapse;"> <thead> <tr> <th style="text-align: left;">dimension connection</th> <th style="text-align: center;">Ø 1/2"</th> <th style="text-align: center;">1/2"</th> <th style="text-align: center;">3/4"</th> </tr> </thead> <tbody> <tr> <td>N₁</td> <td style="text-align: center;">18</td> <td style="text-align: center;">18</td> <td style="text-align: center;">26</td> </tr> <tr> <td>L₁</td> <td style="text-align: center;">2</td> <td style="text-align: center;">2</td> <td style="text-align: center;">2</td> </tr> <tr> <td>L₂</td> <td style="text-align: center;">15</td> <td style="text-align: center;">17</td> <td style="text-align: center;">21</td> </tr> </tbody> </table>						dimension connection	Ø 1/2"	1/2"	3/4"	N ₁	18	18	26	L ₁	2	2	2	L ₂	15	17	21
dimension connection	Ø 1/2"	1/2"	3/4"																		
N ₁	18	18	26																		
L ₁	2	2	2																		
L ₂	15	17	21																		

1) подключение возможно начиная с высоты 140 мм
 2) для моделей 221-224 + 30 мм

Подключение со встроенным термовентилем Completto без термостатической головки

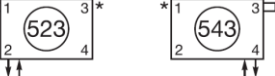
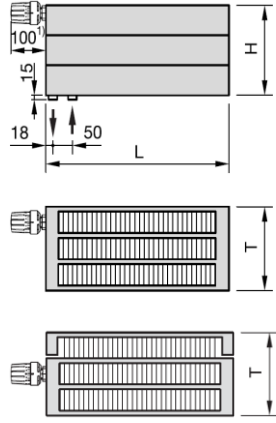
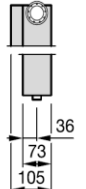
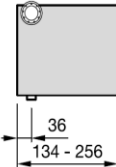
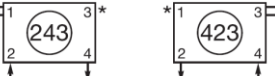
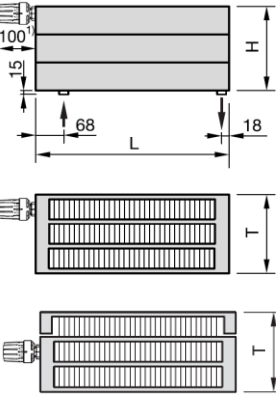
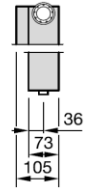
	<p>184,93</p>		<p>211 - 224</p> 	<p>321 - 544</p> 
	<p>184,93</p>		<p>211 - 224</p> 	<p>321 - 544</p> 